

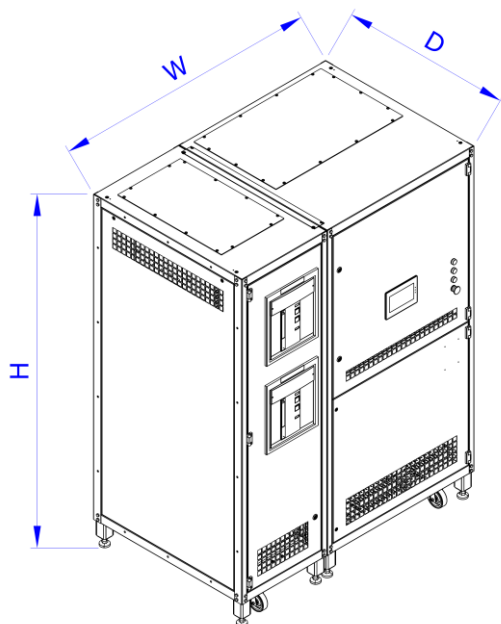

DATASHEET EPX 1000A

DESCRIPTION



- KEY FEATURES:**
- UP TO 4 SAVING LEVELS
 - ON BOARD BYPASS
 - ON BOARD CONTROL SYSTEM
 - REMOTE CONTROL
 - DATA LOGGER
 - ETHERNET/4G MODEM CONNECTION
 - ELECTRICAL PARAMETERS MONITORING
 - ON BOARD 7" HMI

MAIN DATA

Rated Voltage (*)	400 Vac	Load variation	100 %
Rated Frequency (*)	50 Hz	Auxiliary voltage	24Vdc
Recommended plant voltage	PH-N 235 V - PH-PH 407 V	Insulation Class	Class I
Cabinet	Sheet metal RAL7042	IP/NEMA Type	IP30/TYPE 1
IEC standards	IEC/EN 61439-1: 2022 IEC/EN 61439-2: 2021	UL/CSA standards	UL1012 CSA C22.1 No.107.1

(*) Different Voltage and Frequency can be offered on request.

RATED DATA

CODE	RATED CURRENT [A]	RATED POWER (@400V) [kVA]	I _{cw} / I _{pk} [kAx1s] / [kA]	RATED BYPASS CURRENT [A]	EFFICIENCY	WEIGHT [kg]	DIMENSIONS (W x D x H) [mm]
EPX1000C400I2NG00	1000	693	40 / 84	1250	99,60%	865	1410 x 860 x 1960
EPX1000G400I2NG00	1000	693	40 / 84	1600	99,60%	865	1410 x 860 x 1960
EPX1000C400I2NG02	1000	693	50 / 105	1250	99,60%	865	1410 x 860 x 1960
EPX1000G400I2NG02	1000	693	50 / 105	1600	99,60%	865	1410 x 860 x 1960

AMBIENT CHARACTERISTICS

Working Temperature Range	-5°C to +40°C	Humidity	0%...97%
Storage Temperature Range	-10°C to +65°C	Cooling system	Natural + Forced
Installation	Indoor		

**SERVER CONNECTION**

Connection type	Ethernet 4G Modem (Optional)	Communication Protocol	TCP/IP v4 GPRS/3G/4G
Minimum upload connection speed	800Kbps	Sampling time	1 min 2 sec

NETWORK POWER ANALYZER ACCURACY

Current	0,25 a 6A: $\pm(0,5\% \text{ FS} + 1\text{DGT})$ 0,03 a 0,25A: $\pm(0,5\% \text{ FS} + 7\text{DGT})$	Frequency	$\pm 0,1 \text{ Hz}$ (48 to 62Hz)
PH-PH Voltage	$\pm(1,5\% \text{ FS} + 1 \text{ DGT})$	PH-N Voltage	$\pm(0,5\% \text{ FS} + 1 \text{ DGT})$
Active/Apparent Power	0,25 a 6A: $\pm(1\% \text{ FS} + 1\text{DGT})$ 0,03 a 0,25A: $\pm(1\% \text{ FS} + 5\text{DGT})$	Reactive Power	0,25 a 6A: $\pm(2\% \text{ FS} + 1\text{DGT})$ 0,03 a 0,25A: $\pm(2\% \text{ FS} + 5\text{DGT})$
Active Energy	Class 2 (start-up "I": 30mA)	Reactive Energy	Class 3 (start-up "I": 30mA)

CURRENT TRANSFORMERS ACCURACY

Precision class	Class 0,5	Dielectric strength	3 kV - 50 Hz - 1 min.
Frequency range	50 - 60 Hz	Max overload	1,2 In
Insulation Class	E (120°C)		

1 MINUTE SAMPLED PARAMETERS

Output PH-N Voltage [V]	V L1-N V L2-N V L3-N	Output PH-PH Voltage [V]	VL1-L2 VL2-L3 VL3-L1
Current [A]	A-L1 A-L2 A-L3 A N	Active Power [W]	W L1 W L2 W L3 W total
Reactive Power [VAR]	VAR L1 VAR L2 VAR L3 VAR total	Power Factor	PF L1_L2_L3 PF-I L1_L2_L3 PFC L1_L2_L3
Frequency [Hz]	Hz	Temperature [°C]	T°C
Energy [kWh]	kWh	Reactive Energy [kVARh]	kVARh
Voltage Harmonic Distortion [%]	THD V1 THD V2 THD V3	Current Harmonic Distortion [%]	THD I1 THD I2 THD I3

2 SECONDS SAMPLED PARAMETERS

Output PH-N Voltage [V]	V L1-N V L2-N V L3-N	Current [A]	A-L1 A-L2 A-L3
Active Power [W]	W	Reactive Power [VAR]	VAR total
Energy [kWh]	kWh	Reactive Energy [kVARh]	kVARh
Power Factor	PF		

ALLOWED OVERLOADS

OVERLOAD	MAX TIME
115%	5 min
106%	30 min
104%	60 min

The overload values refer to the rated saving and bypass current.

The overload protection must be guaranteed by an upstream suitable circuit breaker.



INSTALLATION DIAGRAM EXAMPLES

Configuration where the E-Power is installed upstream the LV Main Breaker (in this case it is necessary to insert the additional protection IP, or equivalent)

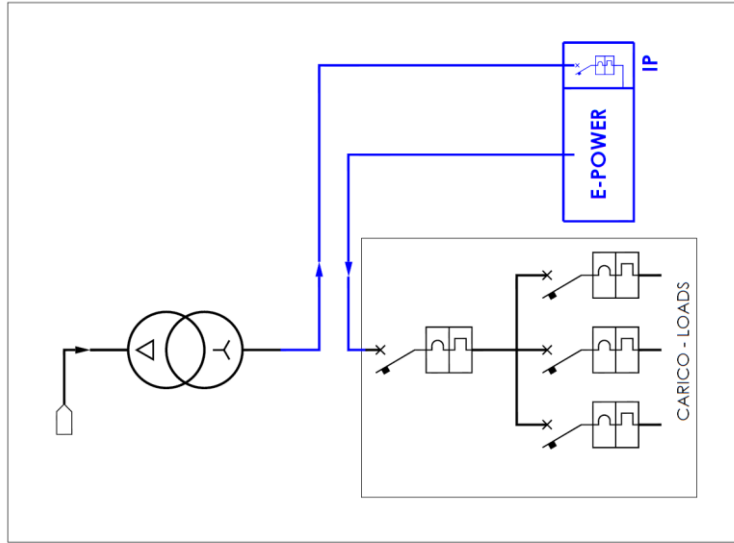

Configuration where the E-Power is installed downstream the main circuit breaker

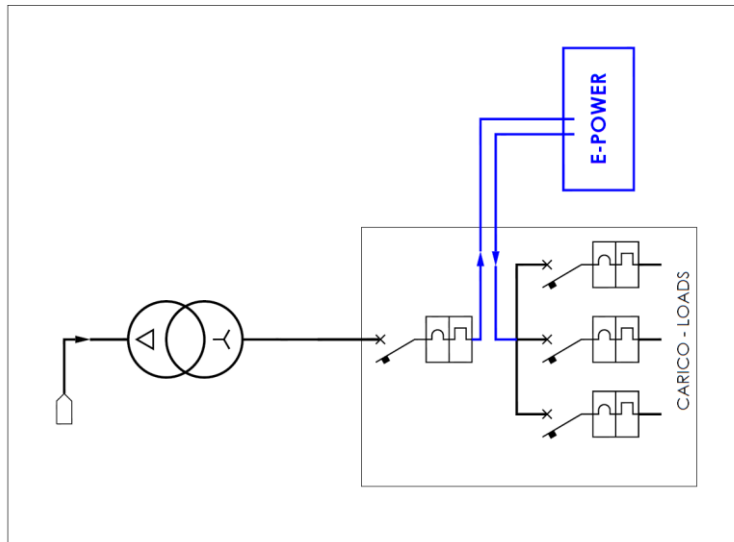

Original plant diagram (where E-Power has to be installed)

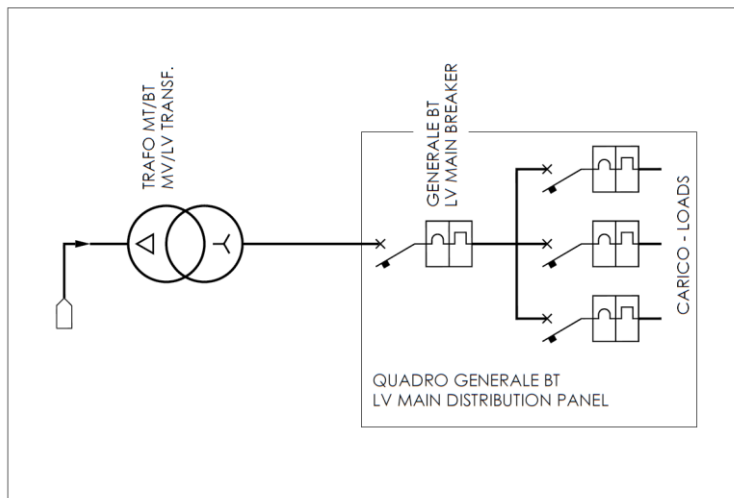



OVERALL DIMENSIONS

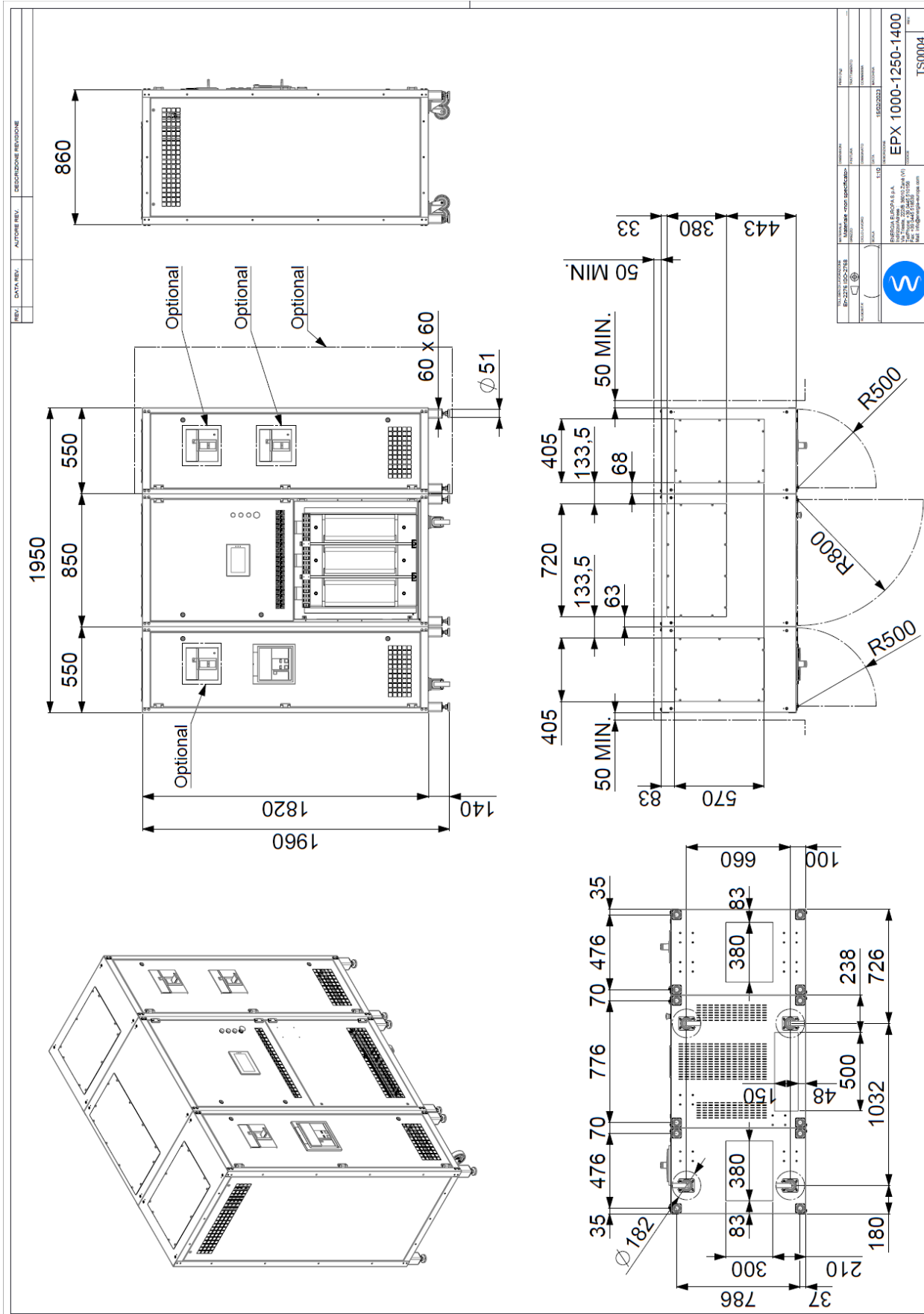



E-POWER FILTER TECHNICAL DATA

Phases	3ph
Rated Voltage	400 Vac
Rated Frequency	50 Hz
Rated Current	1000 A
Voltage Drop PH-N	Liv 1: approx. 9 V Liv 2: approx. 13 V Liv 3: approx. 16 V Liv 4: approx. 20 V
Voltage Drop PH-N With reduced levels	Liv 1-: approx. 8 V Liv 2-: approx. 11 V Liv 3-: approx. 13 V Liv 4-: approx. 15 V
Reference Standards	IEC 60076-1 IEC60076-11

Primary Winding	Open Delta
Secondary Winding	Open Delta
Vectorial Group	Dd0
Winding insulation class	F
Impregnation	VPI
Insulation Class	1.1kV
Dielectric Strength test	3kV
Thermal Detectors	Warning 110°C Alarm 130°C
Primary wind. Resistance (20°C)	85 mΩ
Second. wind. Resistance (20°C)	0.35 mΩ
Vcc	5.0%
Cooling	AN

LOSSES AND EFFICIENCY

No load Losses	400 W
Copper Losses	2100 W
Other E-Power Losses	100 W

Total Losses (@full load)	2600 W
Rated plant Power (PF=0.95)	658 kW
Efficiency (at rated power)	99.6 %

