

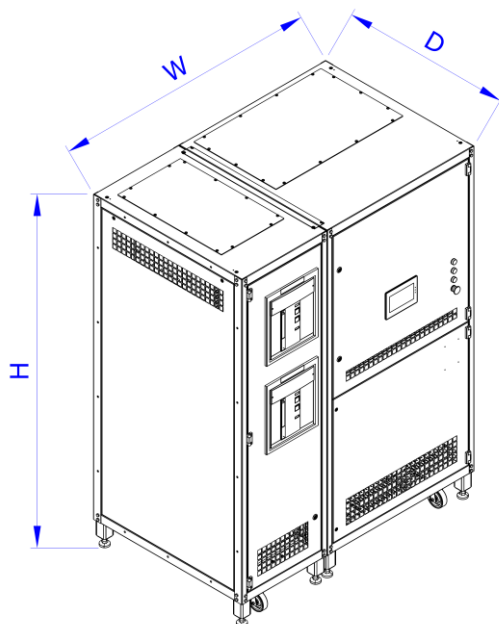

## DATASHEET EPX 1600A

### DESCRIPTION



- KEY FEATURES:**
- UP TO 4 SAVING LEVELS
  - ON BOARD BYPASS
  - ON BOARD CONTROL SYSTEM
  - REMOTE CONTROL
  - DATA LOGGER
  - ETHERNET/4G MODEM CONNECTION
  - ELECTRICAL PARAMETERS MONITORING
  - ON BOARD 7" HMI

### MAIN DATA

Rated Voltage (*)	400 Vac	Load variation	100 %
Rated Frequency (*)	50 Hz	Auxiliary voltage	24Vdc
Recommended plant voltage	PH-N 235 V - PH-PH 407 V	Insulation Class	Class I
Cabinet	Sheet metal RAL7042	IP/NEMA Type	IP30/TYPE 1
IEC standards	IEC/EN 61439-1: 2022 IEC/EN 61439-2: 2021	UL/CSA standards	UL1012 CSA C22.1 No.107.1

(\*) Different Voltage and Frequency can be offered on request.

### RATED DATA

CODE	RATED CURRENT [A]	RATED POWER (@400V) [kVA]	I <sub>cw</sub> / I <sub>pk</sub> [kAx1s] / [kA]	RATED BYPASS CURRENT [A]	EFFICIENCY	WEIGHT [kg]	DIMENSIONS (W x D x H) [mm]
EPX1600C400I2NG00	1600	1109	60 / 132	1800	99,70%	1100	1510 x 960 x 1960
EPX1600G400I2NG00	1600	1109	60 / 132	2000	99,70%	1100	1510 x 960 x 1960
EPX1600C400I2NG02	1600	1109	80 / 176	1800	99,70%	1100	1510 x 960 x 1960
EPX1600G400I2NG02	1600	1109	80 / 176	2000	99,70%	1100	1510 x 960 x 1960

### AMBIENT CHARACTERISTICS

Working Temperature Range	-5°C to +40°C	Humidity	0%...97%
Storage Temperature Range	-10°C to +65°C	Cooling system	Natural + Forced
Installation	Indoor		

**SERVER CONNECTION**

Connection type	Ethernet 4G Modem (Optional)	Communication Protocol	TCP/IP v4 GPRS/3G/4G
Minimum upload connection speed	800Kbps	Sampling time	1 min 2 sec

**NETWORK POWER ANALYZER ACCURACY**

Current	0,25 a 6A: $\pm(0,5\% \text{ FS} + 1\text{DGT})$ 0,03 a 0,25A: $\pm(0,5\% \text{ FS} + 7\text{DGT})$	Frequency	$\pm 0,1 \text{ Hz}$ (48 to 62Hz)
PH-PH Voltage	$\pm(1,5\% \text{ FS} + 1 \text{ DGT})$	PH-N Voltage	$\pm(0,5\% \text{ FS} + 1 \text{ DGT})$
Active/Apparent Power	0,25 a 6A: $\pm(1\% \text{ FS} + 1\text{DGT})$ 0,03 a 0,25A: $\pm(1\% \text{ FS} + 5\text{DGT})$	Reactive Power	0,25 a 6A: $\pm(2\% \text{ FS} + 1\text{DGT})$ 0,03 a 0,25A: $\pm(2\% \text{ FS} + 5\text{DGT})$
Active Energy	Class 2 (start-up "I": 30mA)	Reactive Energy	Class 3 (start-up "I": 30mA)

**CURRENT TRANSFORMERS ACCURACY**

Precision class	Class 0,5	Dielectric strength	3 kV - 50 Hz - 1 min.
Frequency range	50 - 60 Hz	Max overload	1,2 In
Insulation Class	E (120°C)		

**1 MINUTE SAMPLED PARAMETERS**

Output PH-N Voltage [V]	V L1-N V L2-N V L3-N	Output PH-PH Voltage [V]	VL1-L2 VL2-L3 VL3-L1
Current [A]	A-L1 A-L2 A-L3 A N	Active Power [W]	W L1 W L2 W L3 W total
Reactive Power [VAR]	VAR L1 VAR L2 VAR L3 VAR total	Power Factor	PF L1_L2_L3 PF-I L1_L2_L3 PFC L1_L2_L3
Frequency [Hz]	Hz	Temperature [°C]	T°C
Energy [kWh]	kWh	Reactive Energy [kVARh]	kVARh
Voltage Harmonic Distortion [%]	THD V1 THD V2 THD V3	Current Harmonic Distortion [%]	THD I1 THD I2 THD I3

**2 SECONDS SAMPLED PARAMETERS**

Output PH-N Voltage [V]	V L1-N V L2-N V L3-N	Current [A]	A-L1 A-L2 A-L3
Active Power [W]	W	Reactive Power [VAR]	VAR total
Energy [kWh]	kWh	Reactive Energy [kVARh]	kVARh
Power Factor	PF		

**ALLOWED OVERLOADS**

<b>OVERLOAD</b>	<b>MAX TIME</b>
115%	5 min
106%	30 min
104%	60 min

The overload values refer to the rated saving and bypass current.

The overload protection must be guaranteed by an upstream suitable circuit breaker.



**INSTALLATION DIAGRAM EXAMPLES**

Configuration where the E-Power is installed upstream the LV Main Breaker (in this case it is necessary to insert the additional protection IP, or equivalent)

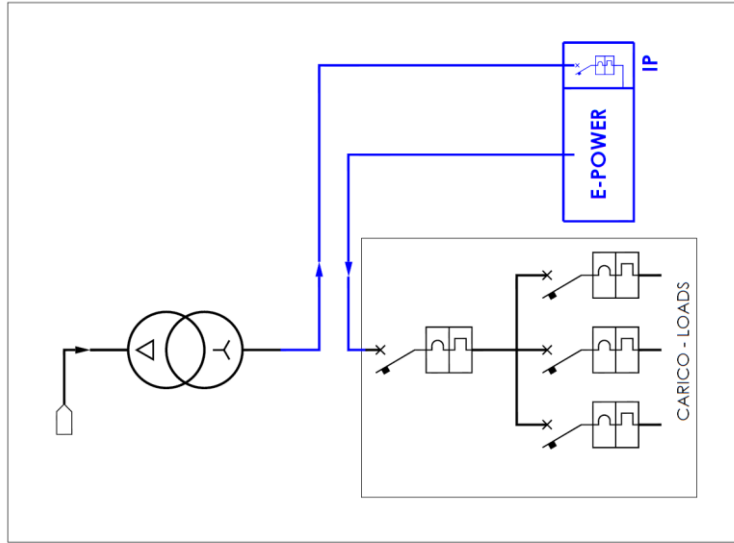

Configuration where the E-Power is installed downstream the main circuit breaker

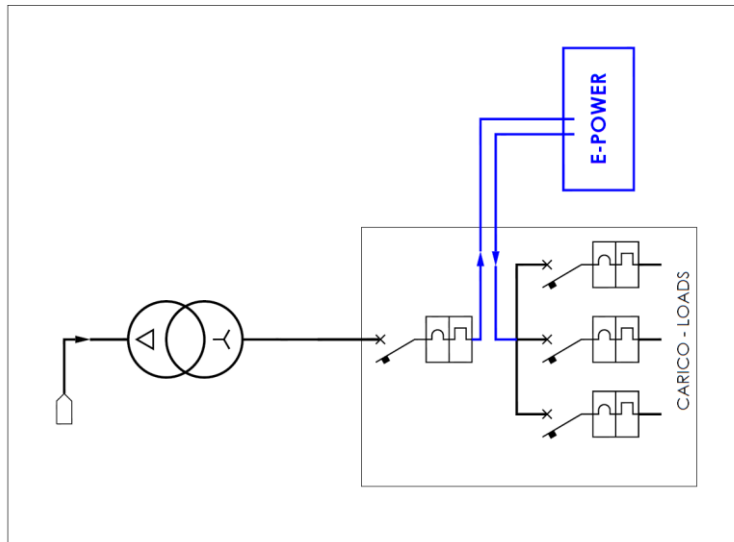

Original plant diagram (where E-Power has to be installed)

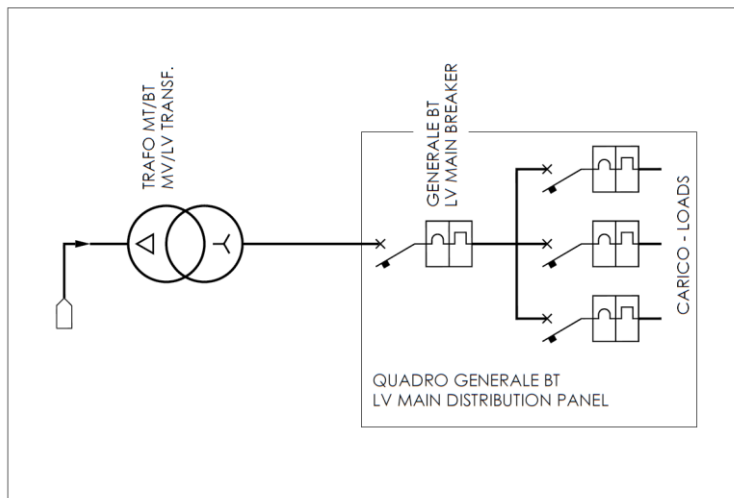



OVERALL DIMENSIONS

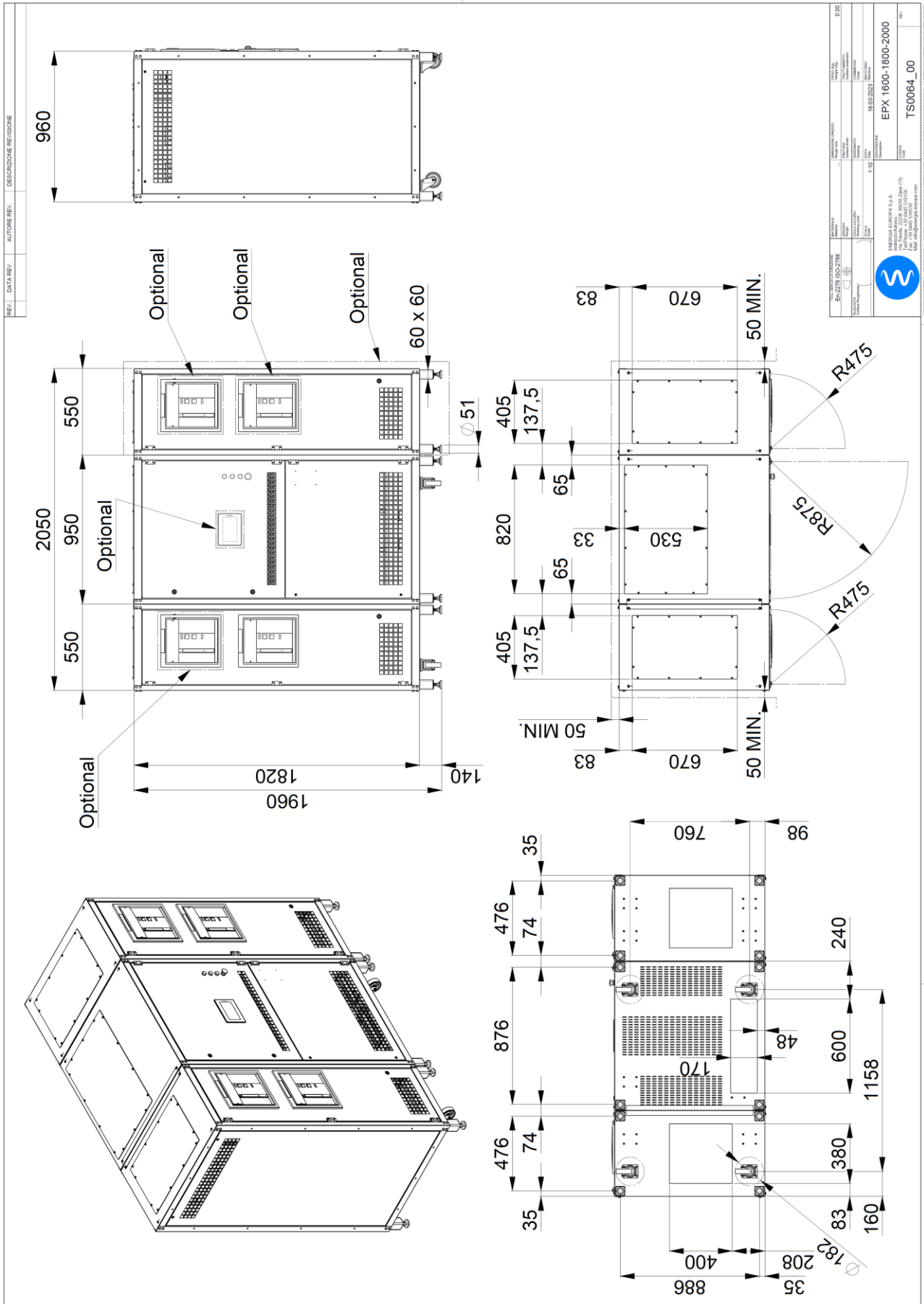



## E-POWER FILTER TECHNICAL DATA

Phases	3ph
Rated Voltage	400 Vac
Rated Frequency	50 Hz
Rated Current	1600 A
Voltage Drop PH-N	Liv 1: approx. 9 V
	Liv 2: approx. 13 V
	Liv 3: approx. 16 V
	Liv 4: approx. 20 V
Voltage Drop PH-N With reduced levels	Liv 1-: approx. 8 V
	Liv 2-: approx. 11 V
	Liv 3-: approx. 13 V
	Liv 4-: approx. 15 V
Reference Standards	IEC 60076-1 IEC60076-11

Primary Winding	Open Delta
Secondary Winding	Open Delta
Vectorial Group	Dd0
Winding insulation class	F
Impregnation	VPI
Insulation Class	1.1kV
Dielectric Strength test	3kV
Thermal Detectors	Warning 110°C
	Alarm 130°C
Primary wind. Resistance (20°C)	26 mΩ
Second. wind. Resistance (20°C)	0.14 mΩ
Vcc	4.1%
Cooling	AN

## LOSSES AND EFFICIENCY

No load Losses	600 W
Copper Losses	2700 W
Other E-Power Losses	100 W

Total Losses (@full load)	3400 W
Rated plant Power (PF=0.95)	1053 kW
Efficiency (at rated power)	99.7 %

